

PRINCIPAL PARTICULARS

LOA	302'-0"
LBP - LWL	290'-0"
BEAM	76'-0"
DEPTH	26'-0"
LOADLINE DRAFT	21'-4"
DESIGN DECK LOAD	10 MT/SQ. M (2048 LBS/SQ. FT)
GENERATORS	(4) x 2250 KW @ 1,800 RPM (WATER-COOLED)
TOTAL KILOWATTS	9,000 KW @ 690 VAC
MAIN PROPULSION	(2) x 2,500 KW @ 620 VAC @ 1,000 RPM (6,704 HP TOTAL)
BOW THRUSTERS	(2) x 880 KW @ 620 VAC @ 1,200 RPM (2,360 HP TOTAL) FIXED PITCH VFD /REVERSING MOTORS
	(1) x 880 KW @ 620 VAC @ 1,200 RPM (1,180 HP TOTAL) CONTROLLABLE PITCH VFD /NON-REVERSING MOTOR
STERN THRUSTER	(1) x 880 KW @ 620 VAC @ 1,200 RPM (1,180 HP) FIXED PITCH VFD/REVERSING MOTORS
FIRE MONITORS	(2) x 5284 GPM/(495 KW @ 690 VAC) /394' REACH-REMOTE CONTROLLED FIRE MONITORS
REGULATORY	USCG SUB I & L /SOLAS/ABS A1 AMS, DPS-2, SPS, ACP, HELIDK, IHM, OSR-C2, ACCU, UWILD, FFY I, CRC, OFFSHORE SUPPORT VESSEL (HLC, HNSL, HDC), E

APPROX. TANK CAPACITIES

BALLAST	702,395 US GAL
FUEL OIL	504,282 US GAL
FRESH WATER	171,344 US GAL
METHANOL/FLAMMABLE	1,724 BARRELS
LIQUID MUD	19,120 BARRELS

SUMMARY TABLE

ACCOMMODATIONS	85 (8x4 MAN, 1x3 MAN, 20x2 MAN, 10x1 MAN)
STATEROOMS	39
HEADS	35
LOUNGE	1
LAUNDRY AREA	1
GALLEY	1
MESS AREA	1
SICK BAY (BERTHS)	3

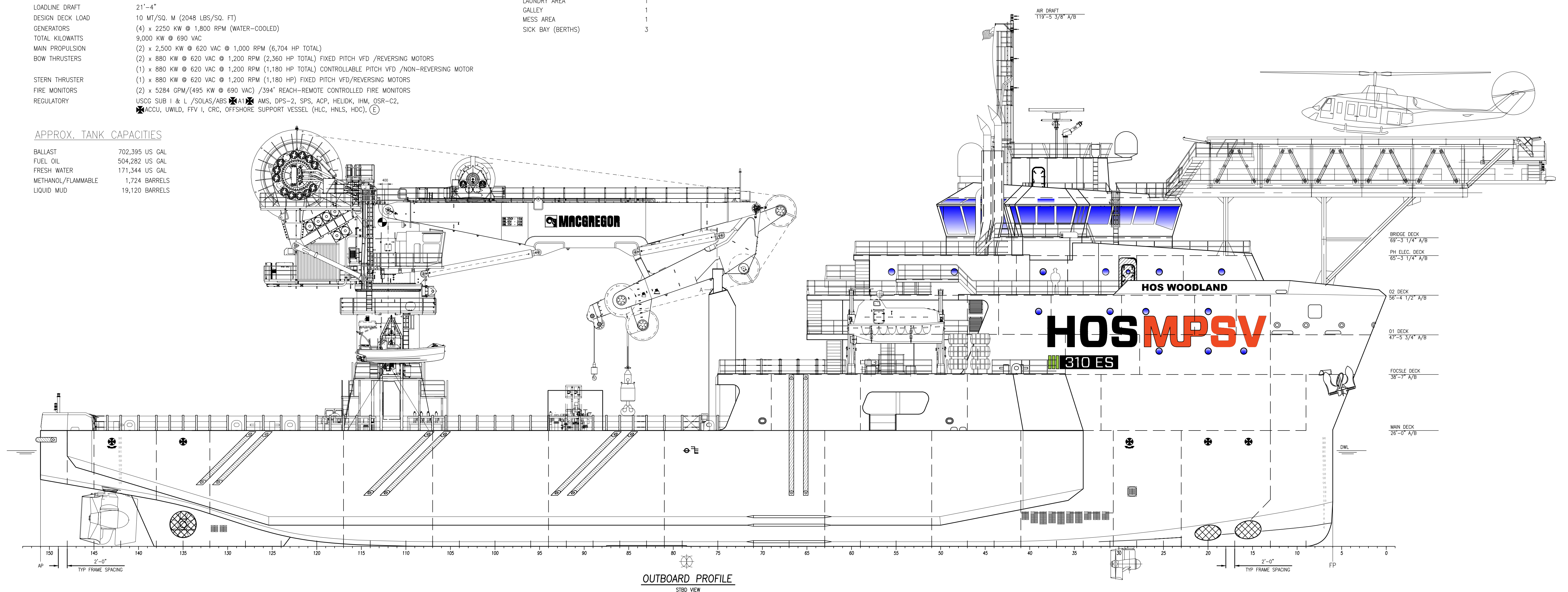

OUTBOARD PROFILE
STBD VIEW

HOSMAX 310ES / HOS WOODLAND

THIS DRAWING, DESIGN CONCEPT AND SPECIFICATIONS ARE THE PROPERTY OF HORNBECK OFFSHORE SERVICES AND ARE FURNISHED ON A CONFIDENTIAL BASIS WITH AN EXPRESSED UNDERSTANDING THAT THEY WILL NOT BE COPIED IN ANY MANNER USED FOR MANUFACTURE, SOLD, TRANSFERRED, NOR USED TO THE DETRIMENT OF SAID FIRM WITHOUT WRITTEN PERMISSION. HOS ©
HORNBECK OFFSHORE SERVICES

DRAWN BY: S. MAUL	302'-0" X 76'-0" X 26'-0"			SIZE D
CHECKED BY: M. STANSBURY	OUTBOARD PROFILE & GENERAL ARRANGEMENT			REV. 8
APPROVED BY: J. GUIDRY	TASK No. 7299	DRAWING No. 1,001	SCALE: AS NOTED DATE: 02/15/2024	REV. 8
	HULL No. 242	SY: ESG	SHEET 1 OF 5	

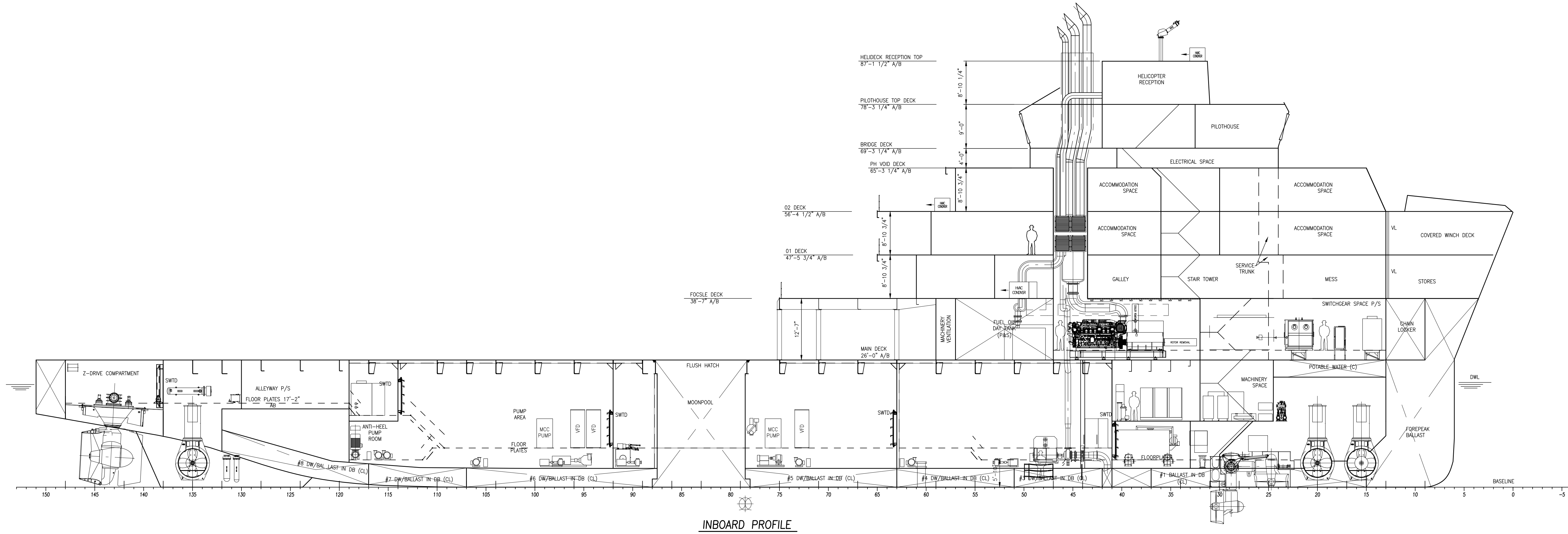

INBOARD PROFILE

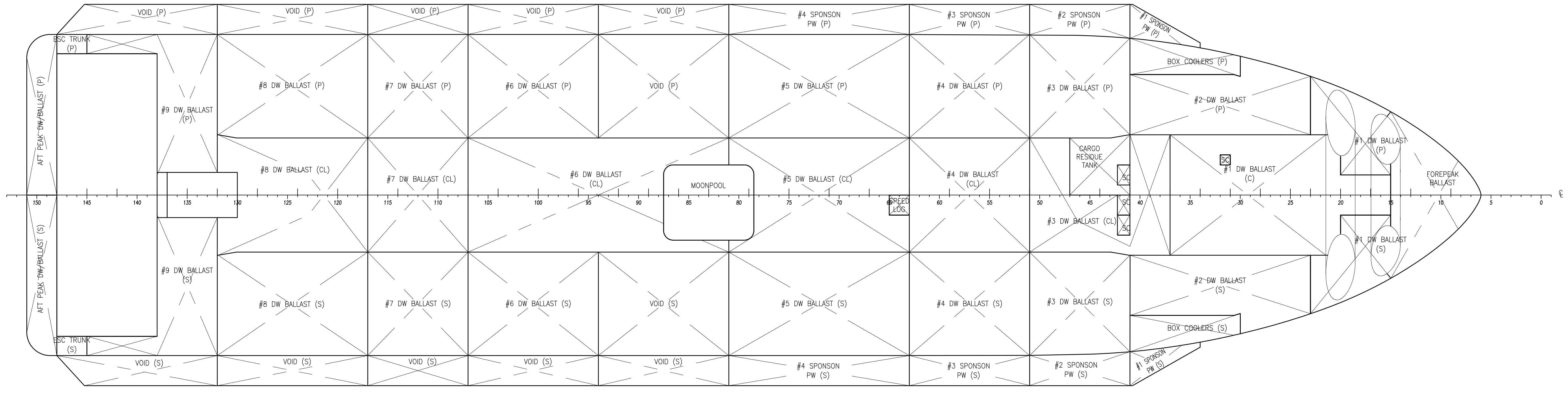

TANK TOP

	OUTBOARD PROFILE & GENERAL ARRANGEMENT		SIZE D	
	THIS DRAWING, DESIGN CONCEPT AND SPECIFICATIONS ARE THE PROPERTY OF HORNBECK OFFSHORE SERVICES AND ARE FURNISHED ON A CONFIDENTIAL BASIS WITH AN EXPRESSED UNDERSTANDING THAT THEY WILL NOT BE COPIED IN ANY MANNER USED FOR MANUFACTURE, SALE, TRANSFER, NOR USED TO THE DETRIMENT OF SAID FIRM WITHOUT WRITTEN PERMISSION.	TASK No. 7299 HULL No. 242	DRAWING No. 1.001 SY: ESG	SCALE: AS NOTED DATE: 02/15/2024 SHEET 2 OF 5
	HORNBECK OFFSHORE SERVICES			REV. 8

D

D

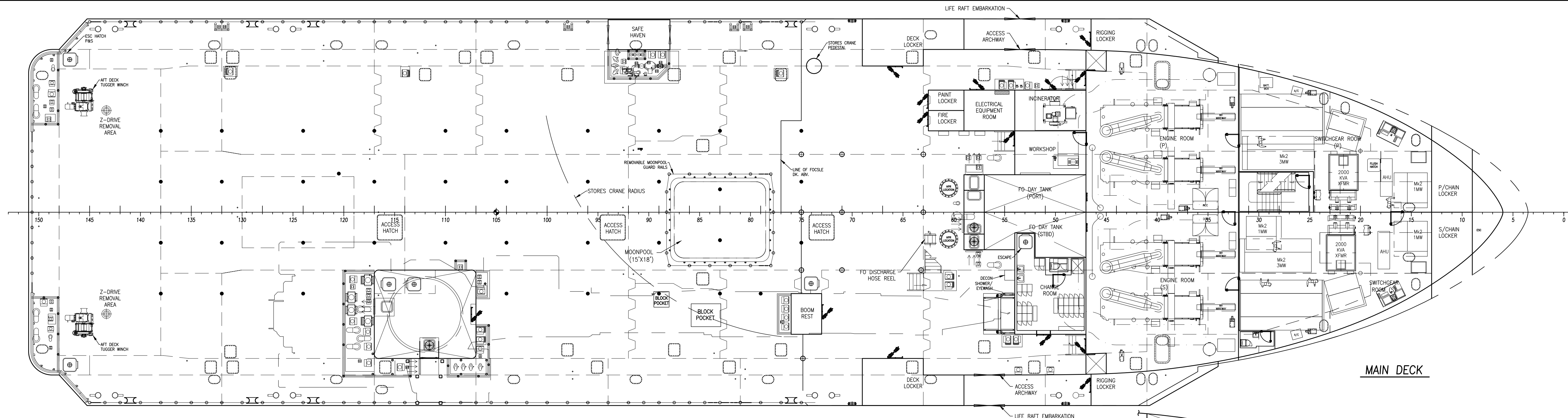

MAIN DECK

C

C

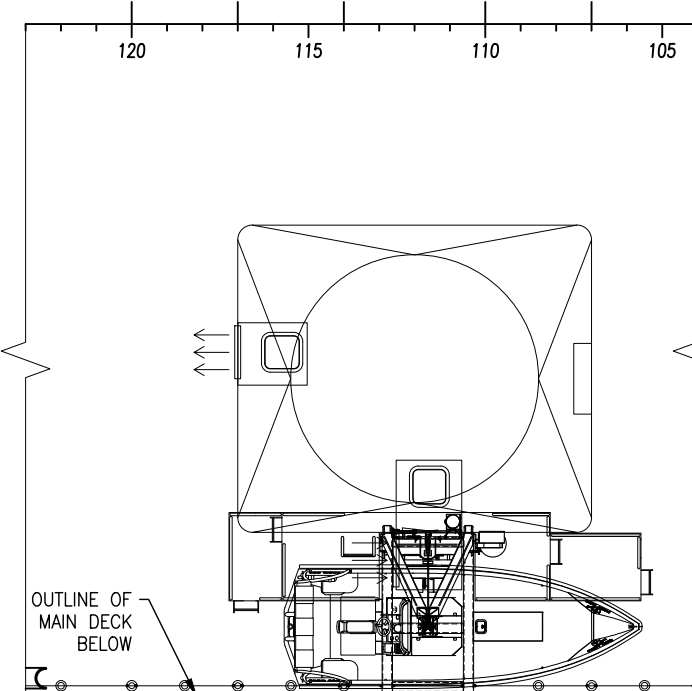

RESCUE BOAT PLATFORM
34'-0" ABL

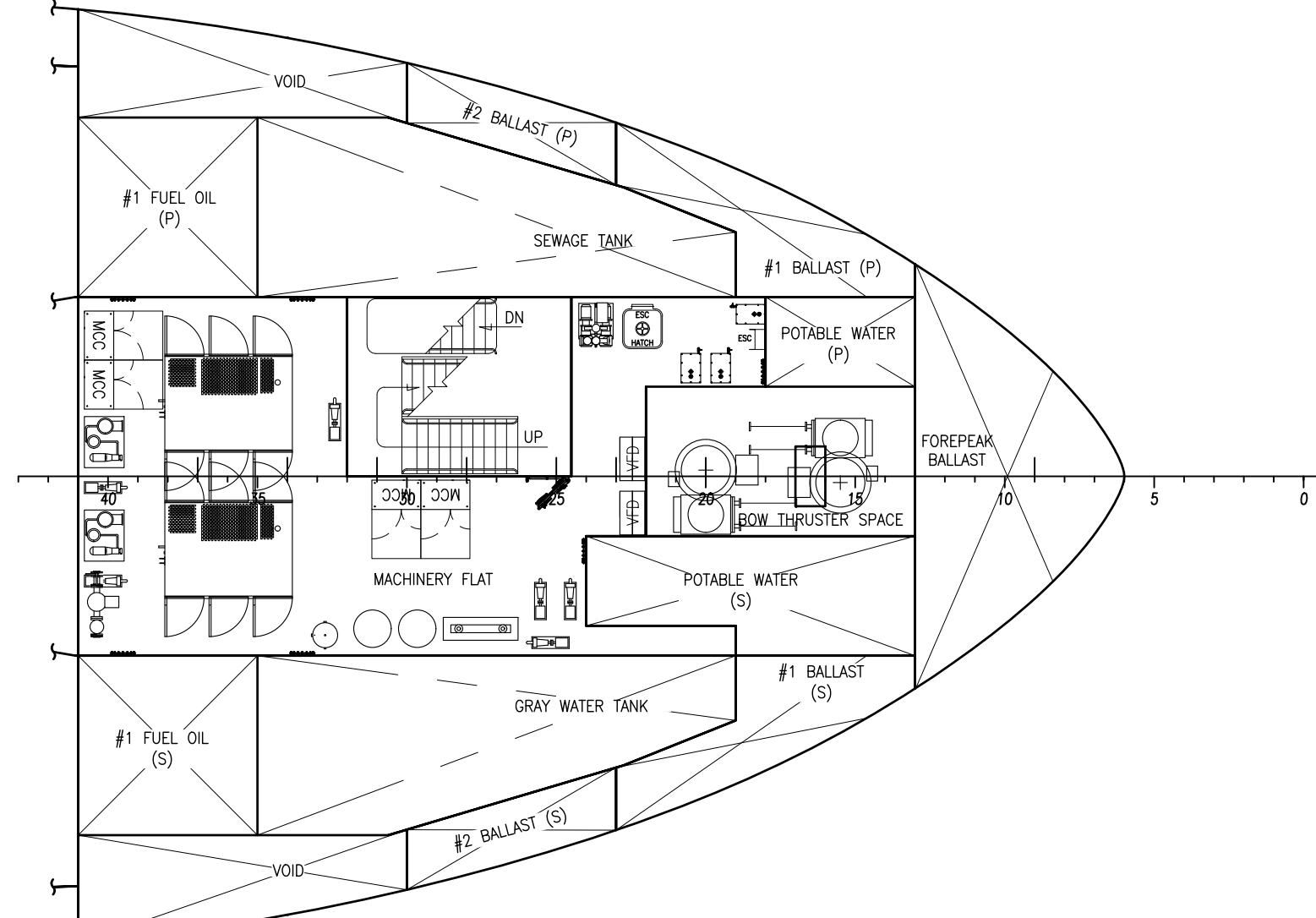

MEZZANINE FLAT

B

B

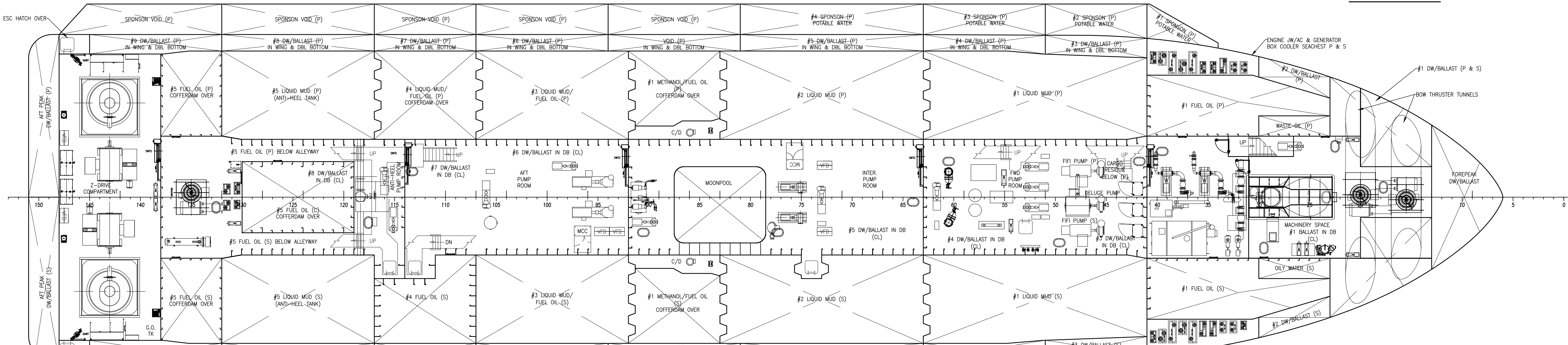

HOLD PLAN

A

A

THIS DRAWING, DESIGN CONCEPT AND SPECIFICATIONS ARE THE PROPERTY OF HORNBECK OFFSHORE SERVICES AND ARE FURNISHED ON A CONFIDENTIAL BASIS WITH AN EXPRESSED UNDERSTANDING THAT THEY WILL NOT BE COPIED IN ANY MANNER USED FOR MANUFACTURING, SOLID, TRANSFERRED, NOR USED TO THE DETRIMENT OF SAID FIRM WITHOUT WRITTEN PERMISSION. HOS

OUTBOARD PROFILE & GENERAL ARRANGEMENT			SIZE D
TASK No. 7299	DRAWING No. 1.001	SCALE: AS NOTED	REV. 8
HULL No. 242	SY: ESG	DATE: 02/15/2024 SHEET 3 OF 5	

HORNBECK OFFSHORE SERVICES

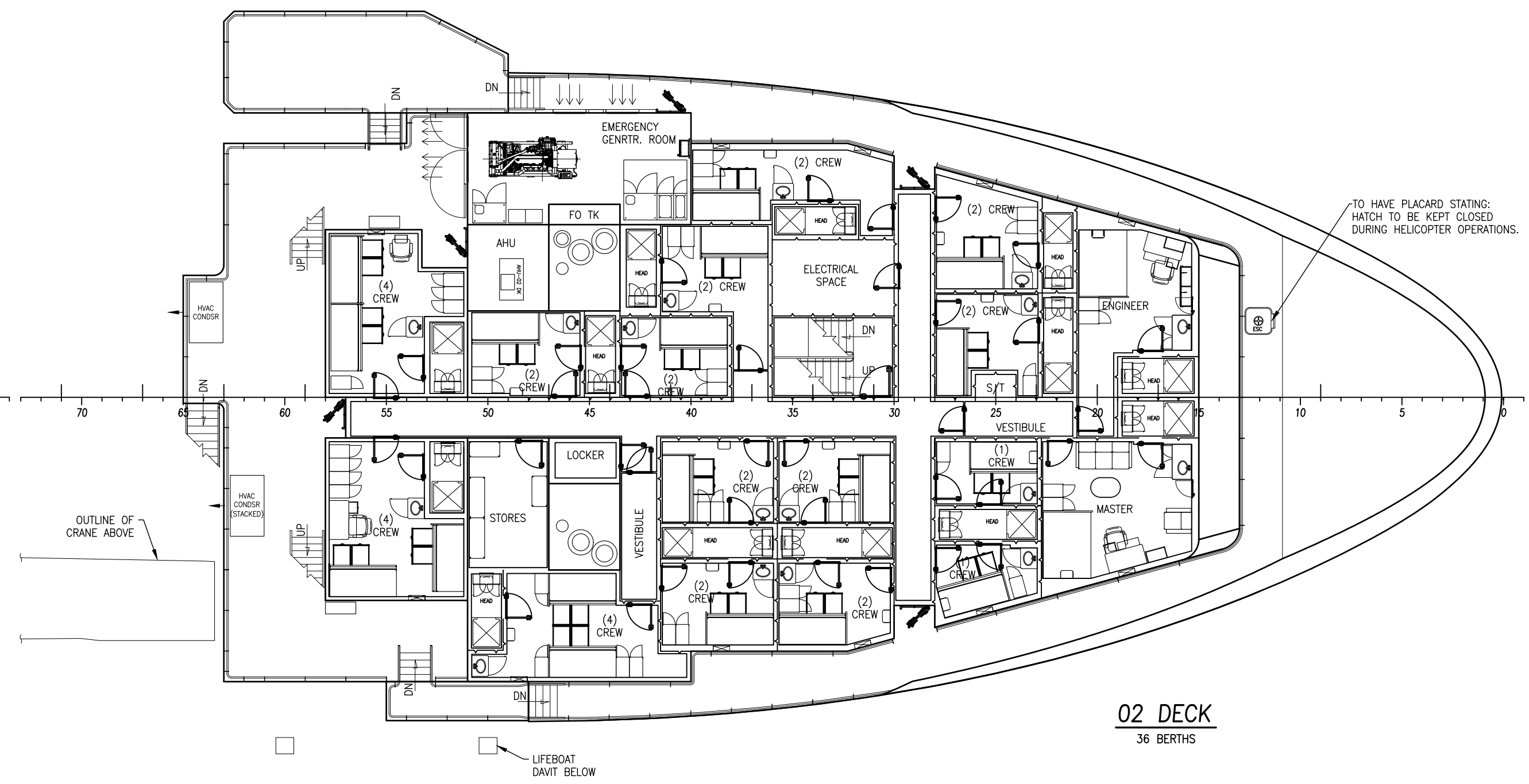
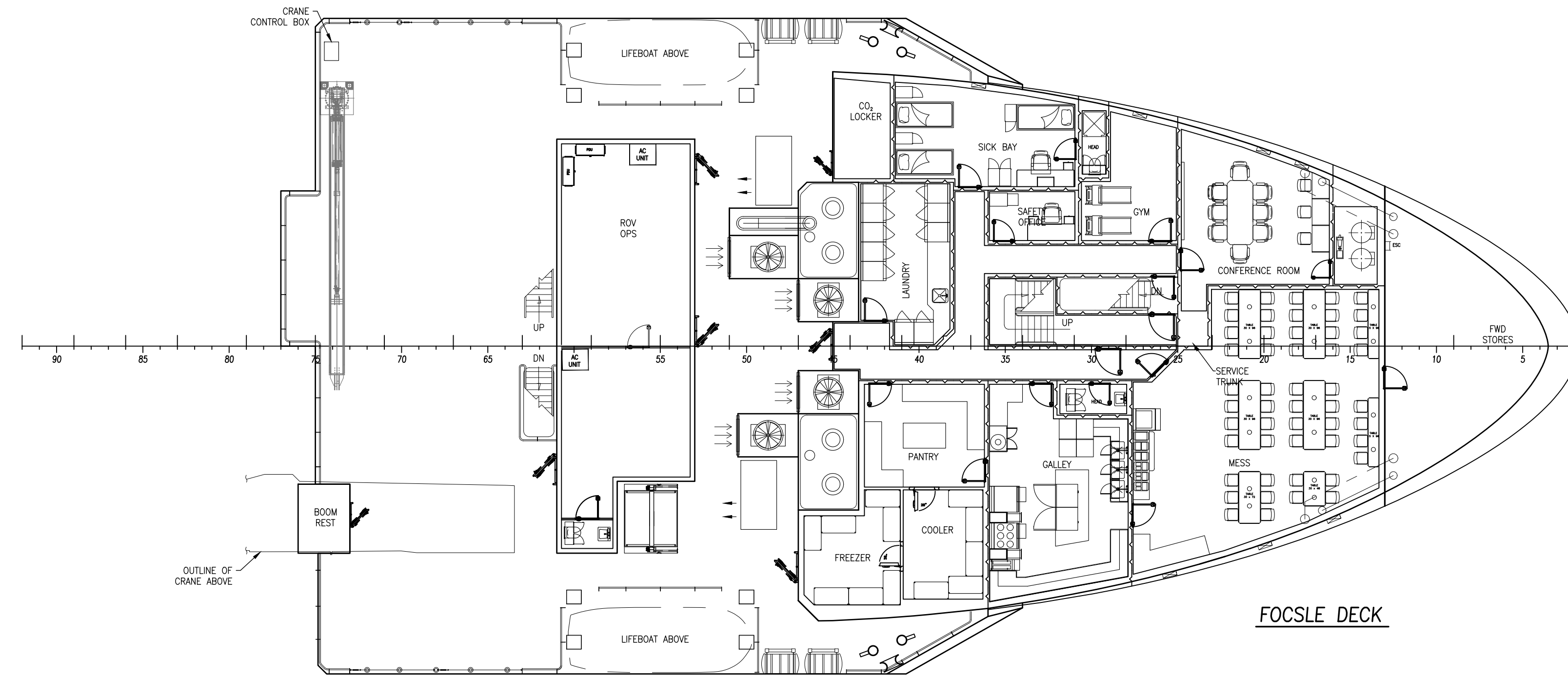
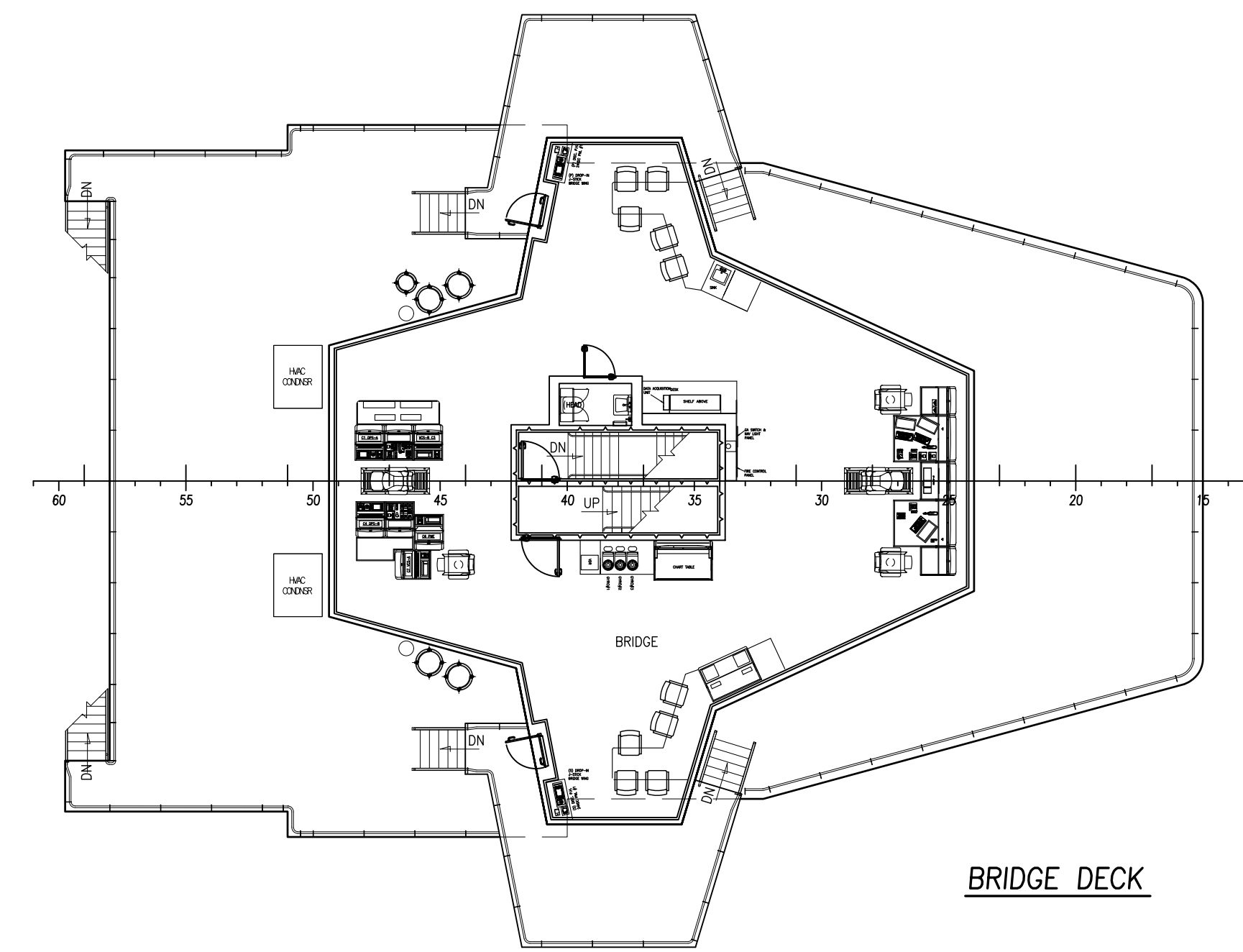
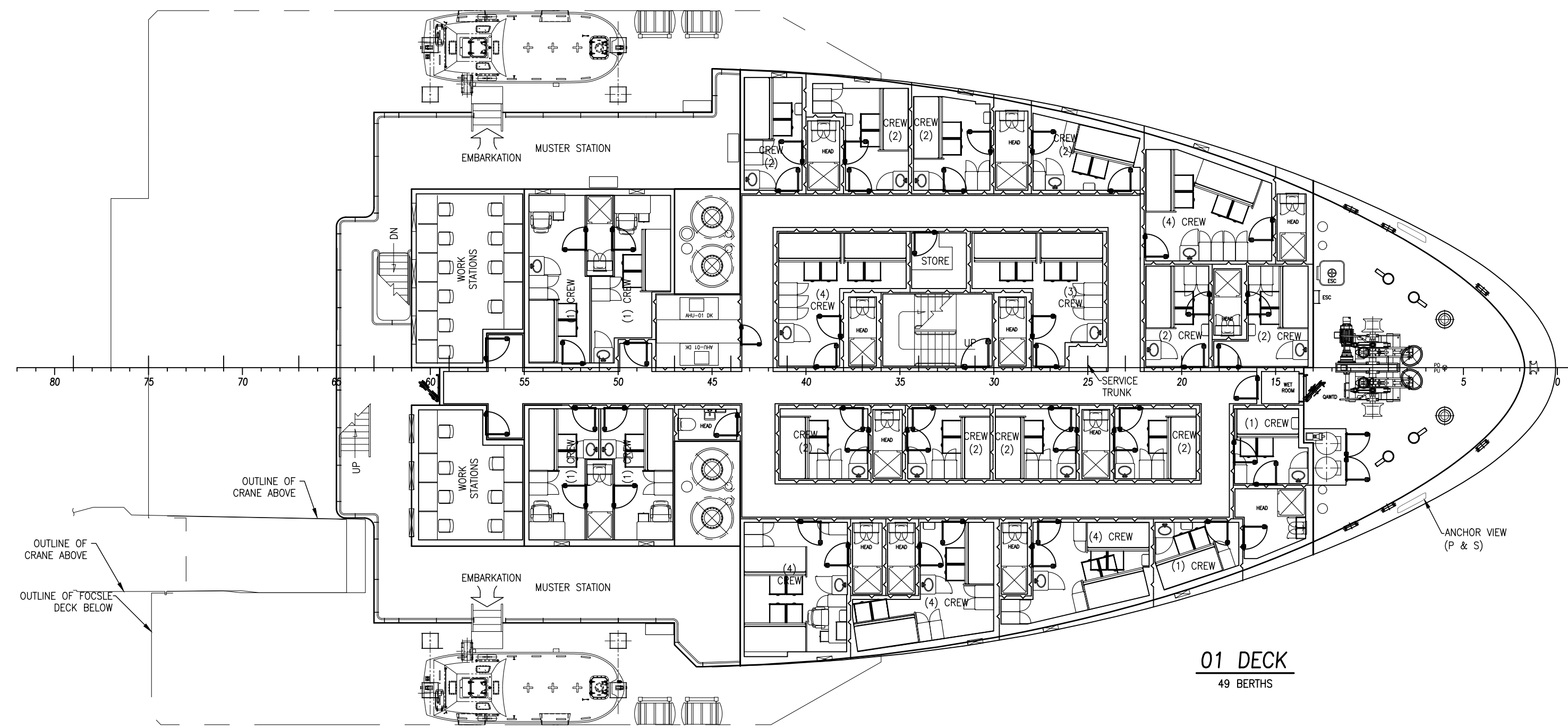

<p>HORNBECK OFFSHORE SERVICES</p>	<p>THIS DRAWING, DESIGN CONCEPT AND SPECIFICATIONS ARE THE PROPERTY OF HORNBECK OFFSHORE SERVICES AND ARE FURNISHED ON A CONFIDENTIAL BASIS WITH AN EXPRESSED UNDERSTANDING THAT THEY WILL NOT BE COPIED IN ANY MANNER USED FOR MANUFACTURING, SALES, TRANSPORTATION, NOR USED TO THE DETRIMENT OF SAID FIRM WITHOUT WRITTEN PERMISSION.</p>			<p>OUTBOARD PROFILE & GENERAL ARRANGEMENT</p>	<p>SIZE D</p>
	<p>TASK No. 7299</p>	<p>DRAWING No. 1,001</p>	<p>SCALE: AS NOTED</p>	<p>DATE: 02/15/2024</p>	<p>REV. 8</p>
	<p>HULL No. 242</p>	<p>SY: ESG</p>	<p>SHEET 4 OF 5</p>	<p></p>	<p></p>
	<p>808</p>				<p></p>

40

39

38

37

36

35

34

33

D

D

C

C

B

B

A

A

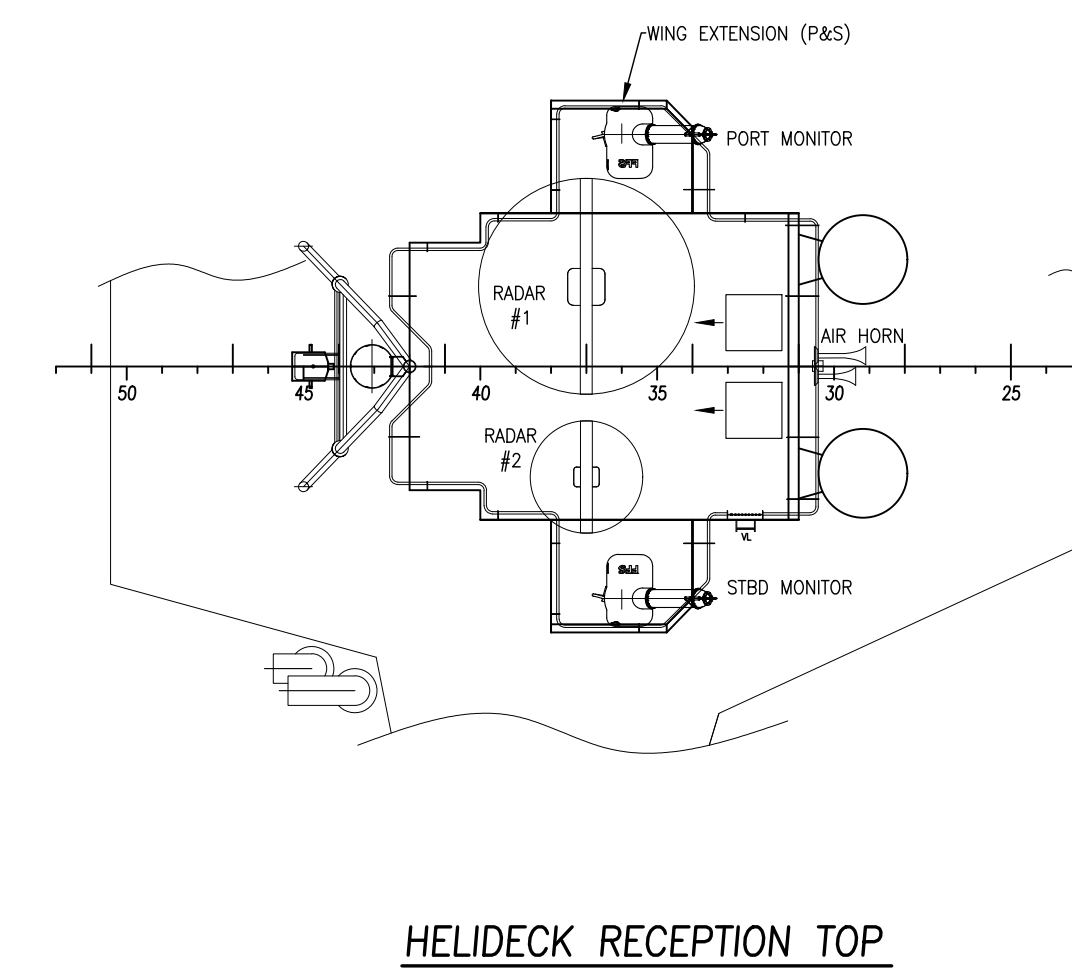
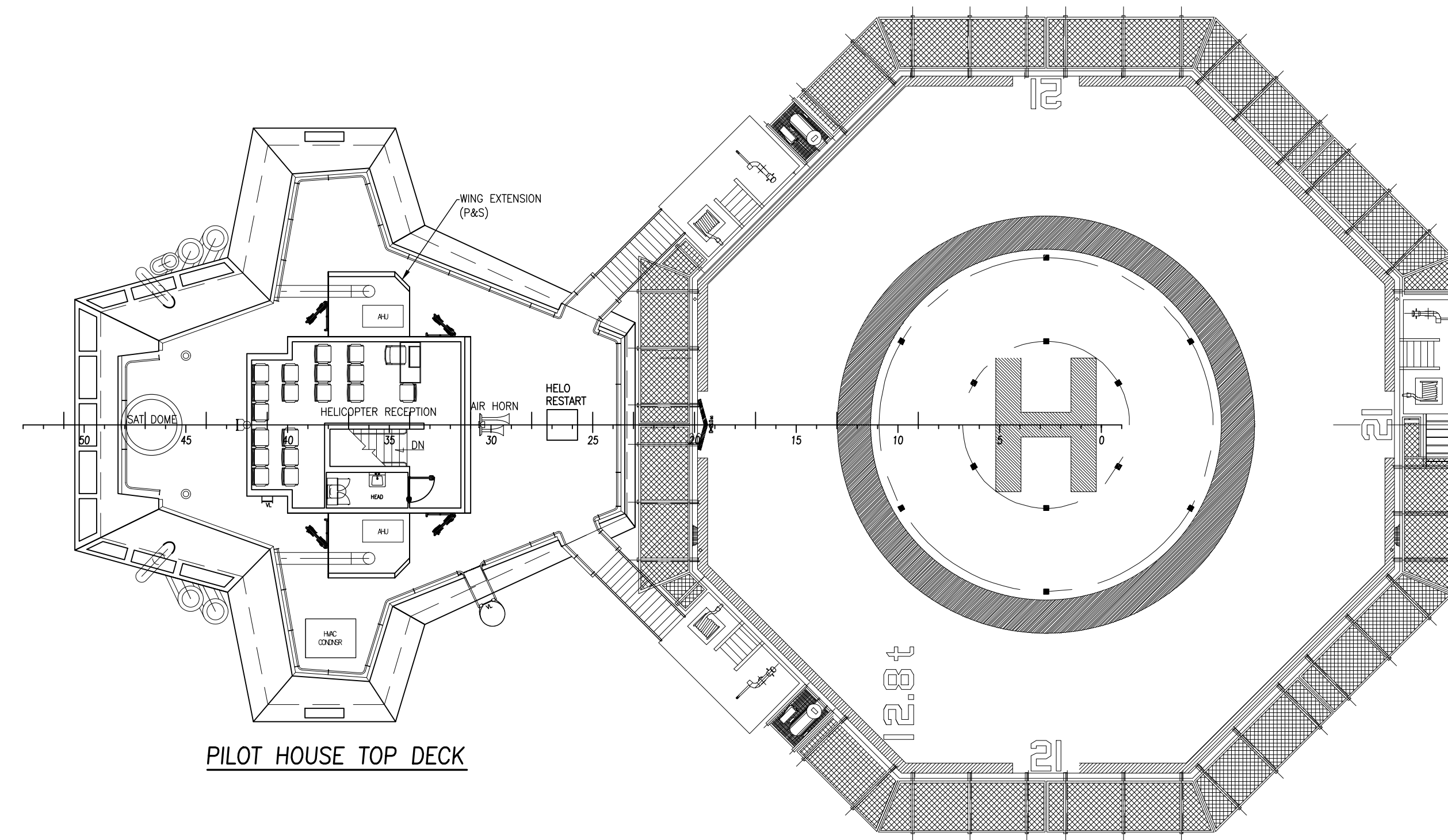

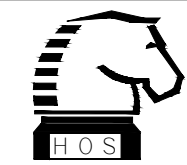
 HORNBECK OFFSHORE SERVICES	THIS DRAWING, DESIGN CONCEPT AND SPECIFICATIONS ARE THE PROPERTY OF HORNBECK OFFSHORE SERVICES AND ARE FURNISHED ON A CONFIDENTIAL BASIS WITH AN EXPRESSED UNDERSTANDING THAT THEY WILL NOT BE COPIED IN ANY MANNER USED FOR MANUFACTURE, SALE, TRANSFER, NOR USED TO THE DETRIMENT OF SAID FIRM WITHOUT WRITTEN PERMISSION.			OUTBOARD PROFILE & GENERAL ARRANGEMENT	SIZE D
	TASK No. 7299	DRAWING No. 1.001	SCALE: AS NOTED	DATE: 02/15/2024	REV. 8
	HULL No. 242	SY: ESG	SHEET 5 OF 5		

40

39

38

37

36

35

34

33